

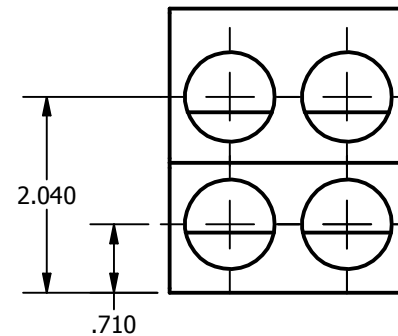

SCREW: E0945	MATERIAL: ALUMINUM	REV: O	 800-776-9775 www.ilsco.com
CAT. NO.: PB4-600	PLATING: EL-TIN	DRAWN BY: CLH SCALE: 1/2	
INFORMATION SHEET: FORM 1	MARKING: ILSCO, D3710, PB4-600, 600MCM-2, AL9CU  	DATE: 12/3/2007 SIZE: A	
			DWG. NO. D3710
			SHEET: 1 OF 1

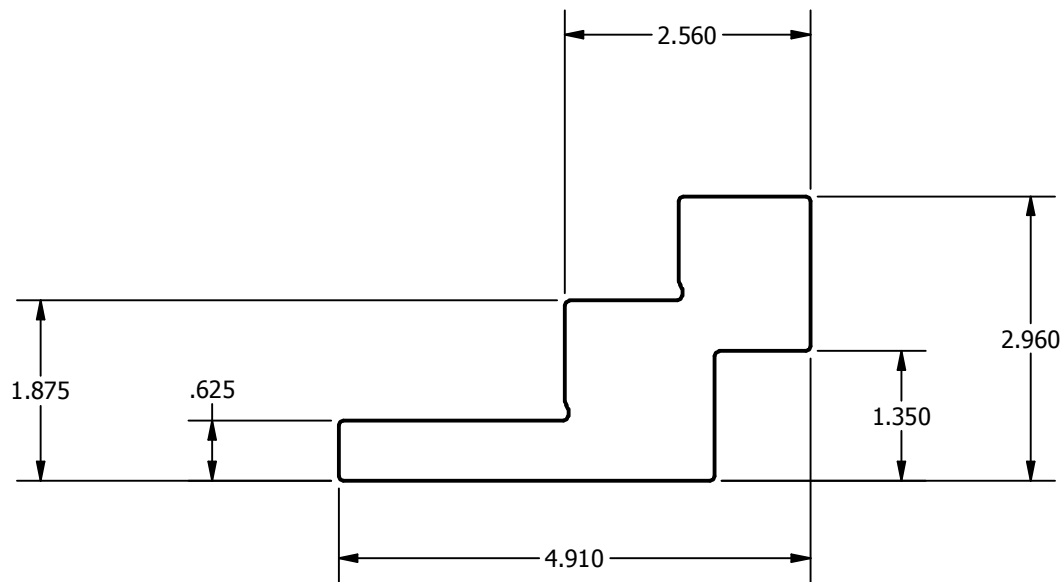
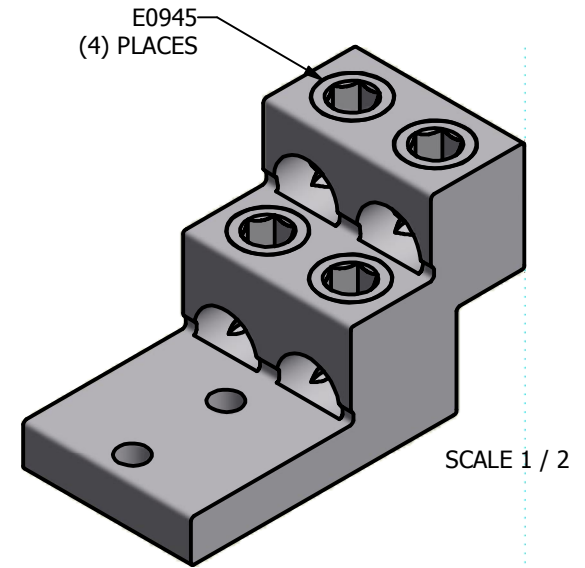
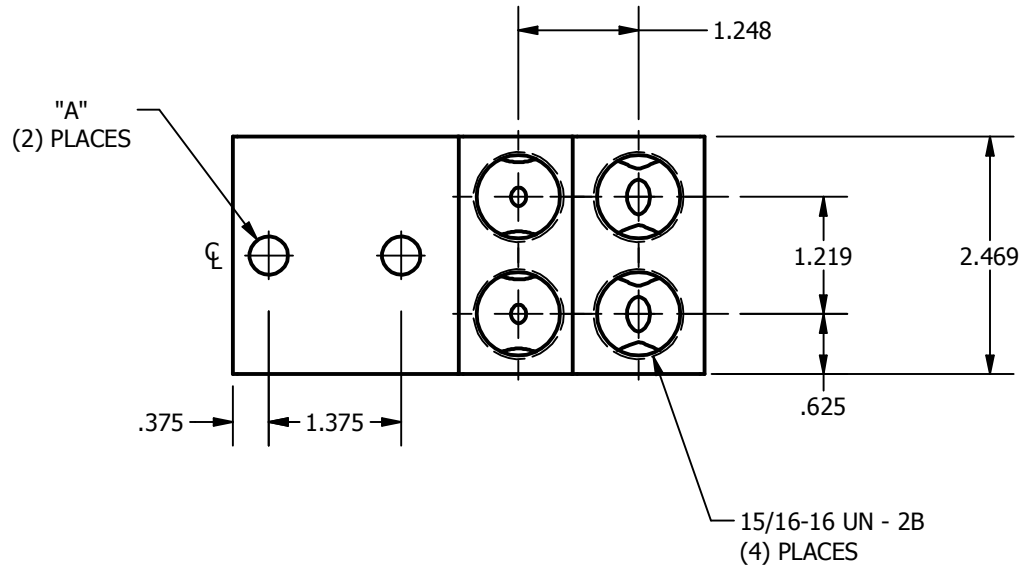

A
.406
.531