

# RATIO Series

AREA/SITE LIGHTER

## FEATURES

- Low profile LED area/site luminaire with a variety of IES distributions for lighting applications such as retail, commercial and campus parking lots
- Featuring Micro Strike Optics which maximizes target zone illumination with minimal losses at the house-side, reducing light trespass issues
- Visual comfort standard
- Compact and lightweight design with low EPA
- 3G rated for high vibration applications including bridges and overpasses
- Control options including photo control, occupancy sensing, NX Distributed Intelligence™ and 7-Pin with networked controls
- Best in class surge protection available



## CONTROL TECHNOLOGY



## SPECIFICATIONS

### CONSTRUCTION

- Rectilinear form mimics the traditional shoebox form factor keeping a similar but updated style and appearance, ideal for retrofit applications
- Die-cast housing with hidden vertical heat fins that are optimal for heat dissipation while keeping a clean smooth outer surface
- Corrosion resistant, die-cast aluminum housing with powder coat paint finish

### OPTICS

- Entire optical aperture illuminates to create a larger luminous surface area resulting in a low glare appearance without sacrificing optical performance
- 80, 160, 320 or 480 midpower LEDs
- 3000K, 4000K or 5000K (70 CRI) CCT
- Zero uplight at 0 degrees of tilt
- Field rotatable optics

### INSTALLATION

- Standard square arm mount, compatible with B3 drill pattern
- Optional universal mounting block for ease of installation during retrofit applications. Available as an option or accessory for square and round poles.
- Knuckle arm fitter option available for 2-3/8" OD tenon. Max tilt of 60 degrees with 4 degree adjustable increments. (Restrictions apply for 7-pin options)

### ELECTRICAL

- Universal 120-277 VAC or 347-480 VAC input voltage, 50/60 Hz
- Ambient operating temperature -40°C to 40°C
- Drivers have greater than 90% power factor and less than 20% THD
- LED drivers have output power over-voltage, over-current protection and short circuit protection with auto recovery
- Field replaceable surge protection device provides 20kA protection meeting ANSI/IEEE C62.41.2 Category C High and Surge Location Category C3; Automatically takes fixture off-line for protection when device is compromised

### CONTROLS

- Photo control, occupancy sensor and wireless available for complete on/off and dimming control
- 7-pin ANSI C136.41-2013 photocontrol receptacle option available for twist lock photocontrols or wireless control modules (control accessories sold separately)
- 0- 10 V Dimming Drivers are standard and dimming leads are extended out of the luminaire unless control options require connection to the dimming leads. Must specify if wiring leads are to be greater than the 6" standard
- NX Distributed Intelligence™ available with in fixture wireless control module, features dimming and occupancy sensor

### CERTIFICATIONS

- DLC® (DesignLights Consortium Qualified), with some Premium Qualified configurations. Please refer to the DLC website for specific product qualifications at [www.designlights.org](http://www.designlights.org)
- Listed to UL1598 and CSA C22.2#250.0-24 for wet locations and 40°C ambient temperatures
- 3G rated for ANSI C136.31 high vibration applications
- Fixture is IP66 rated
- Meets IDA recommendations using 3K CCT configuration at 0 degrees of tilt
- This product qualifies as a "designated country construction material" per FAR 52.225-11 Buy American-Construction Materials under Trade Agreements effective 04/23/2020. See [Buy American Solutions](http://Buy American Solutions)

### WARRANTY

- 5 year limited warranty
- See [HLI Standard Warranty](http://HLI Standard Warranty) for additional information

KEY DATA	
Lumen Range	3,000–48,000
Wattage Range	25–340
Efficacy Range (LPW)	118–155
Fixture Projected Life (Hours)	L70>60K
Weights lbs. (kg)	13.5–24 (6.1–10.9)



DATE: \_\_\_\_\_ LOCATION: \_\_\_\_\_

TYPE: \_\_\_\_\_ PROJECT: \_\_\_\_\_

CATALOG #: \_\_\_\_\_

# RATIO SERIES

AREA/SITE LIGHTER

## ORDERING GUIDE

Example: RAR1-80L-25-3K7-2-UNV-ASQ-BL-NXWE-BC

CATALOG #

### ORDERING INFORMATION

Series	# LEDs - Wattage	CCT/CRI	Distribution	Optics Rotation	Voltage
RAR1 Ratio Area Size 1	80L-25 25W - 3,000 Lumens	3K7 3000K, 70 CRI	2 IES TYPE II	Blank for no rotation	UNV Universal 120-277V
	80L-39 39W - 5,200 Lumens	4K7 4000K, 70 CRI	3 IES TYPE III	L Optic rotation left	120 120V
	80L-50 50W - 6,000 Lumens	5K7 5000K, 70 CRI	4W IES TYPE IV	R Optic rotation right	208 208V
	160L-70 70W - 9,000 Lumens		4F IES TYPE IV Forward		240 240V
	160L-100 100W - 12,000 Lumens		5QW IES TYPE V		277 277V
	160L-115 115W - 15,000 Lumens				347 347V
	160L-135 135W - 18,000 Lumens				480 480V
RAR2 Ratio Area Size 2	320L-110 110W - 15,000 Lumens				
	320L-140 140W - 18,000 Lumens				
	320L-165 165W - 21,000 Lumens				
	480L-185 185W - 24,000 Lumens				
	480L-210 210W - 27,000 Lumens				
	480L-240 240W - 30,000 Lumens				
	480L-255 255W - 36,000 Lumens				
	480L-295 295W - 42,000 Lumens				
480L-340 340W - 48,000 Lumens					

Mounting	Color	Control Options Network	Options
ASQ Arm mount for square pole/flat surface	BLT Black Matte Textured	NXWE NX Wireless Enabled (module + radio)	BC Backlight control
ASQU Universal arm mount for square pole/flat surface	BLS Black Gloss Smooth	NXSPW_F NX Wireless, PIR Occ. Sensor, Daylight Harvesting <sup>4</sup>	F Fusing (must specify voltage)
Mounting Round Poles	DBT Dark Bronze Matte Textured	NXSP_F NX, PIR Occ. Sensor, Daylight Harvesting <sup>4</sup>	TB Terminal block
A_ Arm mount for round pole <sup>1</sup>	DBS Dark Brone Gloss Smooth	Control Options Other	2PF 2 power feed with 2 drivers <sup>2</sup>
A_U Universal arm mount for round pole <sup>1</sup>	GTT Graphite Matte Textured	SCP-40F Programmable occupancy sensor <sup>3</sup>	
Mounting Other	LGS Light Grey Gloss Smooth	7PR 7-Pin twist lock receptacle	
WB Wall bracket	PSS Platinum Silver Smooth	7PR-SC 7-Pin receptacle with shorting cap	
MAF Mast arm fitter for 2-3/8" OD horizontal arm	WHT White Matte Textured	7PR-MD40F Low voltage sensor for 7PR	
K Knuckle	WHS White Gloss Smooth	7PR-TL 7-Pin PCR with photocontrol	
	VGT Verde Green Textured	ADD AutoDim Timer Based Dimming	
	Color Option	ADT AutoDim Time of Day Dimming	
	CC Custom Color	Sensors	
		BTS_F Bluetooth Programmable, PIR Occupancy/Daylight Sensor, 360° lens <sup>4</sup>	
		BTSO_F Bluetooth Programmable, PIR Occupancy/Daylight Sensor, 360° lens, up to 12' mounting height <sup>5</sup>	

Notes:

- 1 Replace "\_" with "3" for 3.5"-4.13" OD pole, "4" for 4.18"-5.25" OD pole, "5" for 5.5"-6.5" OD pole
- 2 Not available with 25, 50, 255, 295 & 340W configurations
- 3 At least one SCPREMOTE required to program SCP motion sensor
- 4 Replace "\_" with "14" for up to 14' mounting height, "40F" for 15-40' mounting height
- 5 Replace "\_" with "12" for up to 12' mounting height

### STOCK ORDERING INFORMATION

Catalog Number	Lumens	Wattage	LED Count	CCT/CRI	Voltage	Distribution	Mounting	Finish
RAR1-100-4K-3	12,000	100W	160L	4000K/70CRI	120-277V	Type 3	Square Arm	Bronze
RAR1-100-4K-4W	12,000	100W	160L	4000K/70CRI	120-277V	Type 4W	Square Arm	Bronze
RAR1-135-4K-3	18,000	135W	160L	4000K/70CRI	120-277V	Type 3	Square Arm	Bronze
RAR1-135-4K-4W	18,000	135W	160L	4000K/70CRI	120-277V	Type 4W	Square Arm	Bronze
RAR2-165-4K-3	21,000	165W	320L	4000K/70CRI	120-277V	Type 3	Square Arm	Bronze
RAR2-165-4K-4W	21,000	165W	320L	4000K/70CRI	120-277V	Type 4W	Square Arm	Bronze



currentlighting.com/beacon

© 2022 HLI Solutions, Inc. All rights reserved. Information and specifications subject to change without notice. All values are design or typical values when measured under laboratory conditions.

# RATIO SERIES

AREA/SITE LIGHTER

## OPTIONS AND ACCESSORIES - STOCK (ORDERED SEPARATELY)

Catalog Number	Description
<input type="checkbox"/> RARRPA3DB	Round pole adapter 3.5" to 4.13" for ASQ arm, 3.5" to 4.13" OD pole, dark bronze finish
<input type="checkbox"/> RARA3UDB	Universal mount for square pole or round pole 3.5" to 4.13", dark bronze finish
<input type="checkbox"/> RARBC80L	Ratio backlight control 80L
<input type="checkbox"/> RARBC160L	Ratio backlight control 160L
<input type="checkbox"/> RARBC320L	Ratio backlight control 320L
<input type="checkbox"/> RARBC480L	Ratio backlight control 480L

## ACCESSORIES AND REPLACEMENT PARTS - MADE TO ORDER

Catalog Number	Description
<input type="checkbox"/> RAR-ASQU-XX	Universal arm mount for square pole/flat surface <sup>2</sup>
<input type="checkbox"/> RAR-A_U-XX	Universal arm mount for round poles <sup>1,2</sup>
<input type="checkbox"/> RAR-RPA_-XX	Round pole adapter <sup>1,2</sup>
<input type="checkbox"/> SETAVP-XX	4" square pole top tenon adapter, 2 3/8" OD slipfitter <sup>2</sup>
<input type="checkbox"/> RETAVP-XX	4" round pole top tenon adapter; 2 3/8" OD slipfitter for max. Four fixtures (90o); order 4" round pole adapters separately <sup>2</sup>
<input type="checkbox"/> BIRD-SPIKE-3	Ratio size 1 bird deterrent/spikes
<input type="checkbox"/> BIRD-SPIKE-4	Ratio size 2 bird deterrent/spikes
<input type="checkbox"/> RARWB-XX	Wall bracket - use with Mast Arm Fitter or Knuckle <sup>2</sup>

1 Replace "-" with "3" for 3.5"-4.13" OD pole, "4" for 4.18"-5.25" OD pole, "5" for 5.5"-6.5" OD pole

2 Replace "XX" with desired color/paint finish

## CONTROLS

### Control Options

#### Standalone

**SCPREMOTE** Order at least one per project location to program and control

#### Networked – Wireless

**WIR-RME-L** wiSCAPE External Fixture Module<sup>1,2</sup>

#### NX Networked – Wireless

**NXOFM-1R1D-UNV** NX Wireless, Daylight Harvesting, BLE, 7 pin twisted lock

#### Notes:

1 Works with external networked photosensor

2 wiSCAPE Gateway required for system programming

# RATIO SERIES

AREA/SITE LIGHTER

## PERFORMANCE DATA

Description	Nominal Wattage	System Watts	Dist. Type	5K (5000K NOMINAL 70 CRI)					4K (4000K NOMINAL 70 CRI)					3K (3000K NOMINAL 80 CRI)				
				Lumens	LPW	B	U	G	Lumens	LPW	B	U	G	Lumens	LPW	B	U	G
RAR1	25	25.4	2	3438	135	1	0	1	3445	136	1	0	1	3240	128	1	0	1
			3	3460	136	1	0	1	3467	136	1	0	1	3260	128	1	0	1
			4W	3406	134	1	0	1	3412	134	1	0	1	3209	126	1	0	1
			5QW	3483	137	2	0	1	3490	137	2	0	1	3282	129	2	0	1
	39	39	2	5263	139	1	0	2	5273	139	1	0	2	4960	131	1	0	2
			3	5297	139	1	0	2	5308	140	1	0	2	4991	131	1	0	2
			4W	5200	137	1	0	2	5210	137	1	0	2	4900	129	1	0	2
			5QW	5333	140	3	0	1	5344	141	3	0	1	5025	132	3	0	1
	50	49.8	2	6310	127	1	0	2	6323	127	1	0	2	5946	120	1	0	2
			3	6349	128	1	0	2	6362	128	1	0	2	5983	120	1	0	2
			4W	6233	125	1	0	2	6245	126	1	0	2	5873	118	1	0	2
			5QW	6392	129	3	0	1	6405	129	3	0	1	6023	121	3	0	1
	70	68.4	2	9486	139	1	0	2	9505	139	1	0	2	8938	131	1	0	2
			3	9544	140	1	0	2	9563	140	1	0	2	8993	131	1	0	2
			4W	9395	137	1	0	2	9414	138	1	0	2	8853	129	1	0	2
			5QW	9608	140	4	0	2	9628	141	4	0	2	9054	132	4	0	2
	100	90.0	2	11976	133	2	0	2	12000	133	2	0	2	11285	125	2	0	2
			3	12050	134	2	0	2	12074	134	2	0	2	11354	126	2	0	2
			4W	11861	132	2	0	2	11885	132	2	0	2	11177	124	2	0	2
			5QW	12131	135	4	0	2	12155	135	4	0	2	11431	127	4	0	2
	115	109.7	2	15572	142	2	0	2	15494	141	2	0	2	14871	136	2	0	2
			3	15833	144	2	0	2	15754	144	2	0	2	15121	138	2	0	2
			4W	15281	139	2	0	3	15205	139	2	0	3	14623	133	2	0	3
			5QW	15732	143	4	0	2	15653	143	4	0	2	15024	137	4	0	2
	135	133.3	2	17971	135	3	0	3	17881	134	3	0	3	17163	129	3	0	3
			3	18272	137	2	0	2	18181	136	2	0	2	17450	131	2	0	2
			4W	17635	132	2	0	3	17547	132	2	0	3	16876	127	2	0	3
			5QW	18156	136	4	0	2	18065	136	4	0	2	17339	130	4	0	2

RAR2 Performance Data on next page

\* Lumen values are from photometric test performed in accordance with IESNA LM-79-08. Data is considered to be representative of the configurations shown. Actual performance may differ as a result of end-user environment and application.

# RATIO SERIES

AREA/SITE LIGHTER

## PERFORMANCE DATA

Description	Nominal Wattage	System Watts	Dist. Type	5K (5000K NOMINAL 70 CRI)					4K (4000K NOMINAL 70 CRI)					3K (3000K NOMINAL 80 CRI)				
				Lumens	LPW	B	U	G	Lumens	LPW	B	U	G	Lumens	LPW	B	U	G
RAR2	110	100.3	2	15326	153	2	0	3	15357	153	2	0	3	14442	144	2	0	3
			3	15421	154	2	0	3	15452	154	2	0	3	14531	145	2	0	3
			4W	15180	151	2	0	2	15210	152	2	0	2	14304	143	2	0	2
			5QW	15525	155	4	0	2	15556	155	4	0	2	14629	146	4	0	2
	140	133.2	2	19395	146	2	0	3	19434	146	2	0	3	18276	137	2	0	3
			3	19515	147	2	0	3	19554	147	2	0	3	18389	138	2	0	3
			4W	19210	144	2	0	3	19248	145	2	0	3	18101	136	2	0	3
			5QW	19647	148	5	0	3	19686	148	5	0	3	18513	139	5	0	3
	165	153.6	2	21651	141	3	0	3	21695	141	3	0	3	20402	133	3	0	3
			3	21785	142	3	0	3	21828	142	3	0	3	20527	134	3	0	3
			4W	21444	140	3	0	3	21487	140	3	0	3	20206	132	3	0	3
			5QW	21932	143	5	0	3	21976	143	5	0	3	20666	135	5	0	3
	185	174.5	2	26046	149	3	0	3	26098	150	3	0	3	24543	141	3	0	3
			3	26207	150	3	0	3	26259	150	3	0	3	24694	142	3	0	3
			4W	25797	148	3	0	4	25849	148	3	0	4	24308	139	3	0	4
			5QW	26384	151	5	0	3	26437	152	5	0	3	24861	143	5	0	3
	210	198.2	2	28848	145	3	0	4	28906	146	3	0	4	27184	137	3	0	4
			3	29027	146	3	0	4	29085	147	3	0	4	27351	138	3	0	4
			4W	28572	144	3	0	4	28630	144	3	0	4	26924	136	3	0	4
			5QW	29222	147	5	0	4	29281	148	5	0	4	27536	139	5	0	4
	240	226.9	2	32087	141	3	0	4	32151	142	3	0	4	30235	133	3	0	4
			3	32285	142	3	0	4	32350	143	3	0	4	30422	134	3	0	4
			4W	31780	140	3	0	4	31844	140	3	0	4	29946	132	3	0	4
			5QW	32503	143	5	0	4	32568	144	5	0	4	30627	135	5	0	4
	255	257.0	2	37040	144	3	0	4	36854	143	3	0	4	35373	138	3	0	4
			3	37660	147	3	0	4	37472	146	3	0	4	35966	140	3	0	4
			4W	36347	141	3	0	5	36166	140	3	0	5	34782	135	3	0	5
			5QW	37420	146	5	0	4	37233	145	5	0	4	35736	139	5	0	4
	295	294.0	2	41733	142	3	0	4	41524	141	3	0	4	39855	136	3	0	4
			3	42432	144	3	0	4	42220	144	3	0	4	40523	138	3	0	4
			4W	40953	139	3	0	5	40748	139	3	0	5	39190	133	3	0	5
			5QW	42162	143	5	0	4	41951	143	5	0	4	40264	137	5	0	4
	340	347.1	2	48392	139	4	0	5	48150	139	4	0	5	46215	133	4	0	5
			3	49203	142	3	0	4	48957	141	3	0	4	46989	135	3	0	4
			4W	47488	137	4	0	5	47261	136	4	0	5	45443	131	4	0	5
			5QW	48889	141	5	0	5	48645	140	5	0	5	46689	135	5	0	5

\* Lumen values are from photometric test performed in accordance with IESNA LM-79-08. Data is considered to be representative of the configurations shown. Actual performance may differ as a result of end-user environment and application.

# RATIO SERIES

AREA/SITE LIGHTER

## ELECTRICAL DATA

# OF LEDS	Nominal Wattage	Input Voltage	Oper. Current (Amps)	System Power (Watts)
RAR1	25	120	0.21	25.4
		208	0.12	
		240	0.11	
		277	0.09	
	39	120	0.32	38.0
		208	0.18	
		240	0.16	
		277	0.14	
		347	0.11	
		480	0.08	
	50	120	0.42	49.8
		208	0.24	
		240	0.21	
		277	0.18	
	70	120	0.57	68.4
		208	0.33	
		240	0.29	
		277	0.25	
	100	120	0.75	90.0
		208	0.43	
		240	0.38	
		277	0.32	
	115	120	0.91	109.7
		208	0.53	
		240	0.46	
		277	0.40	
		347	0.32	
		480	0.23	
135	120	1.11	133.3	
	208	0.64		
	240	0.56		
	277	0.48		
	347	0.38		
		480	0.28	

# OF LEDS	Nominal Wattage	Input Voltage	Oper. Current (Amps)	System Power (Watts)
RAR2	110	120	0.84	100.3
		208	0.48	
		240	0.42	
		277	0.36	
	140	120	1.11	133.2
		208	0.64	
		240	0.56	
		277	0.48	
	165	120	1.28	153.6
		208	0.74	
		240	0.64	
	185	120	1.45	174.5
		208	0.84	
		240	0.73	
	210	120	1.65	198.3
		208	0.95	
		240	0.83	
		277	0.72	
	240	120	1.89	226.9
		208	1.09	
		240	0.95	
		277	0.82	
	255	120	2.14	257.0
		208	1.24	
		240	1.07	
		277	0.93	
		347	0.74	
	295	120	2.45	294.0
		208	1.41	
		240	1.23	
		277	1.06	
		347	0.85	
		480	0.61	
	340	120	2.89	347.1
		208	1.67	
		240	1.45	
277		1.25		
347		1.00		
480		0.72		

## LUMINAIRE AMBIENT TEMPERATURE FACTOR (LATF)

Ambient Temperature		Lumen Multiplier
0° C	32° F	1.03
10° C	50° F	1.01
20° C	68° F	1.00
25° C	77° F	1.00
30° C	86° F	0.99
40° C	104° F	0.98
50° C	122° F	0.97

Use these factors to determine relative lumen output for average ambient temperatures from 0-40°C (32-104°F).

## PROJECTED LUMEN MAINTENANCE

Ambient Temperature	OPERATING HOURS					
	0	25,000	TM-21-11 L90 36,000	50,000	100,000	L70 (Hours)
25°C / 77°F	1.00	0.97	0.95	0.93	0.86	238,000
40°C / 104°F	0.99	0.96	0.95	0.93	0.85	225,000

# RATIO SERIES

AREA/SITE LIGHTER

## DIMENSIONS

RAR1

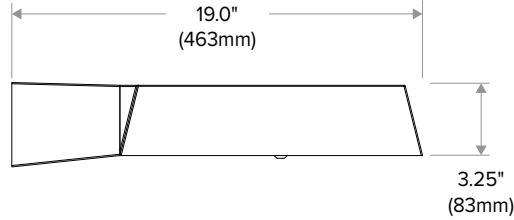
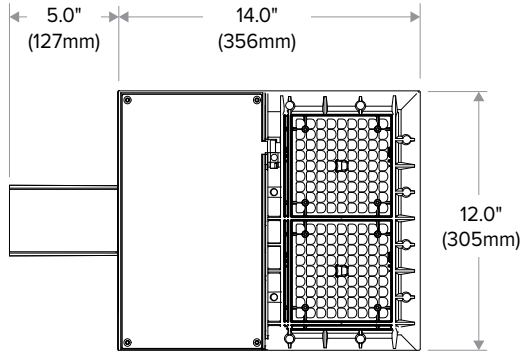

RAR2

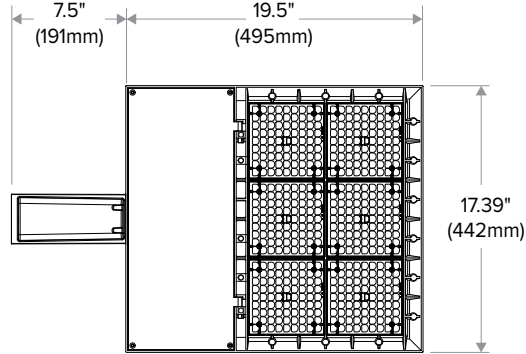

## ADDITIONAL INFORMATION

### MOUNTING

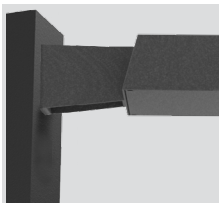

**Arm Mount** – Fixture ships with integral arm for ease of installation. Compatible with Hubbell Outdoor B3 drill pattern.

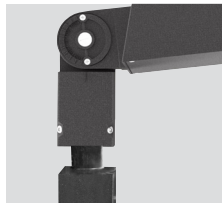

**Knuckle** – Knuckle mount 15° aiming angle increments for precise aiming and control, fits 2-3/8" tenons or pipes.

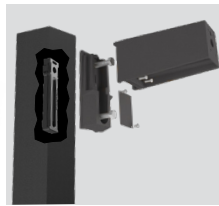

**Universal Mounting** – Universal mounting block for ease of installation. Compatible with drill patterns from 2.5" to 4.5"

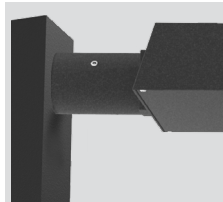

**MAF** – Fits 2-3/8" OD arms Roadway applications.

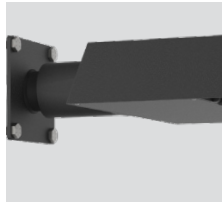

**Wall Mount** – Wall mount bracket designed for building mount applications.

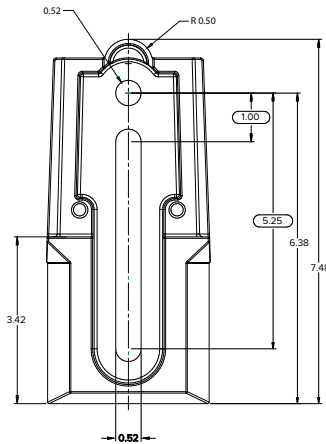

# RATIO SERIES

AREA/SITE LIGHTER

## EPA

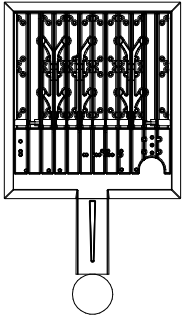

EPA: .607

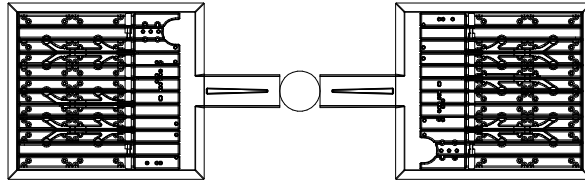

EPA: 1.214

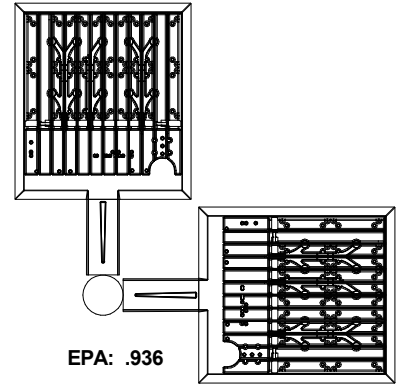

EPA: .936

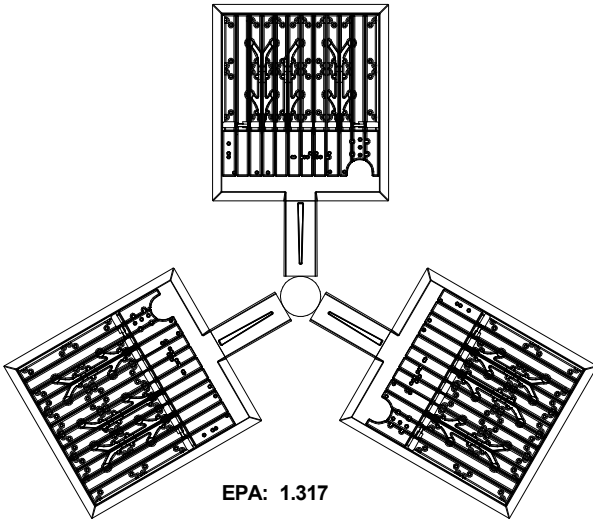

EPA: 1.317

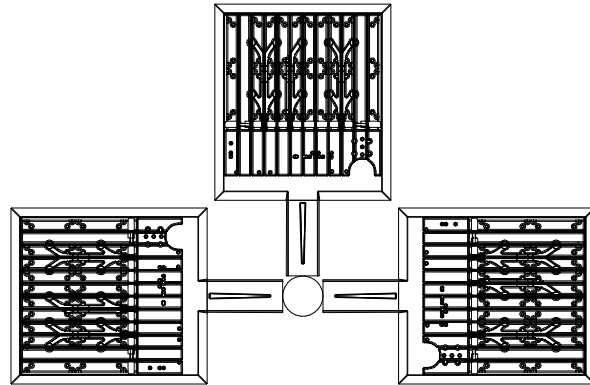

EPA: 1.486

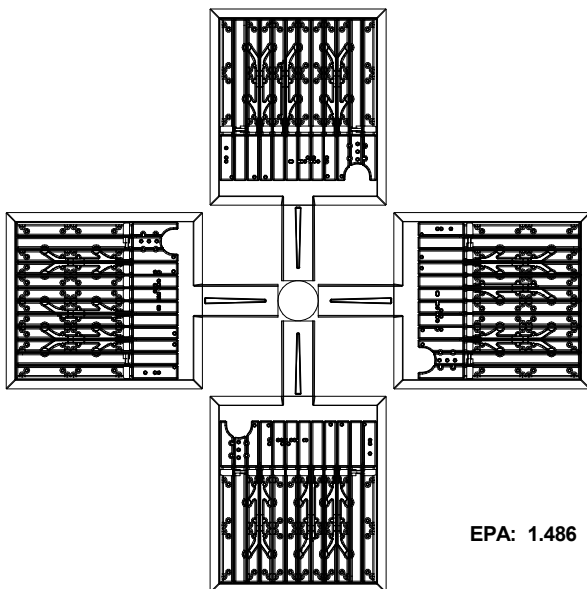

EPA: 1.486



# RATIO SERIES

AREA/SITE LIGHTER

## ADDITIONAL INFORMATION (CONT'D)

### ARM MOUNT (ASQ)

Compatible with Pole drill pattern B3

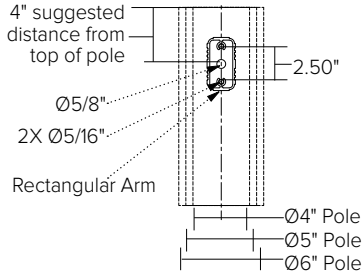

### UNIVERSAL MOUNTING (ASQU)

Compatible with pole drill pattern S2

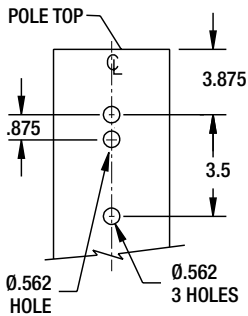

## PROGRAMMED CONTROLS

### ADD-AutoDim Timer Based Options

- Light delay options from 1-9 hours after the light is turned on to dim the light by 10-100%. To return the luminaire to its original light level there are dim return options from 1-9 hours after the light has been dimmed previously.

EX: ADD-6-5-R6

ADD Control Options	Configurations Choices	Example Choice Picked
Auto-Dim Options	1-9 Hours	6
Auto-Dim Brightness	0-9% Brightness	5
Auto-Dim Return	Delay 0-9 Hours	R6

### ADT-AutoDim Time of Day Based Option

- Light delay options from 1AM-9PM after the light is turned on to dim the light by 10-100%. To return the luminaire to its original light level there are dim return options from 1AM-9PM after the light has been dimmed previously.

EX: ADT-6-5-R6

ADD Control Options	Configurations Choices	Example Choice Picked
Auto-Dim Options	12-3 AM and 6-11 PM	6
Auto-Dim Brightness	0-9% Brightness	5
Auto-Dim Return	12-6 AM and 9-11P	R6

# RATIO SERIES

AREA/SITE LIGHTER

## ADDITIONAL INFORMATION (CONT'D)

### NXSP-14F

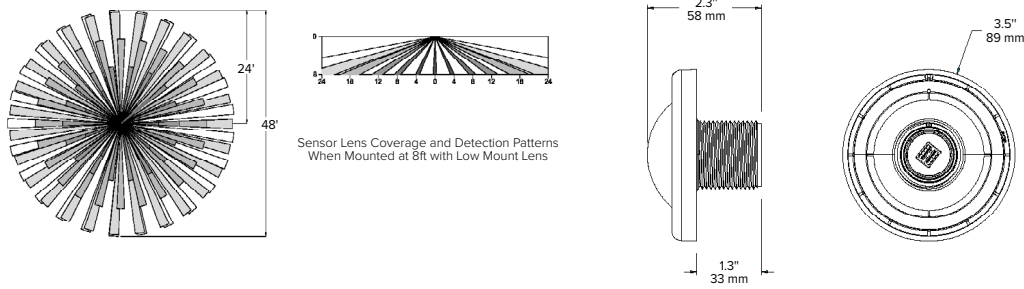

### NXSP-30F

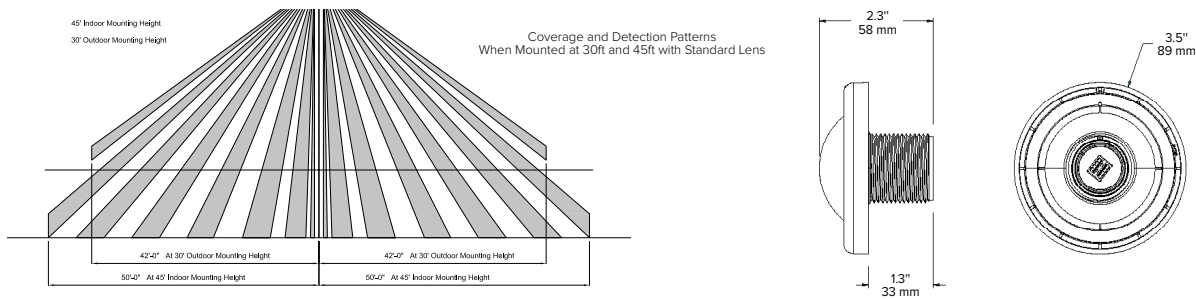

### SCP-40F

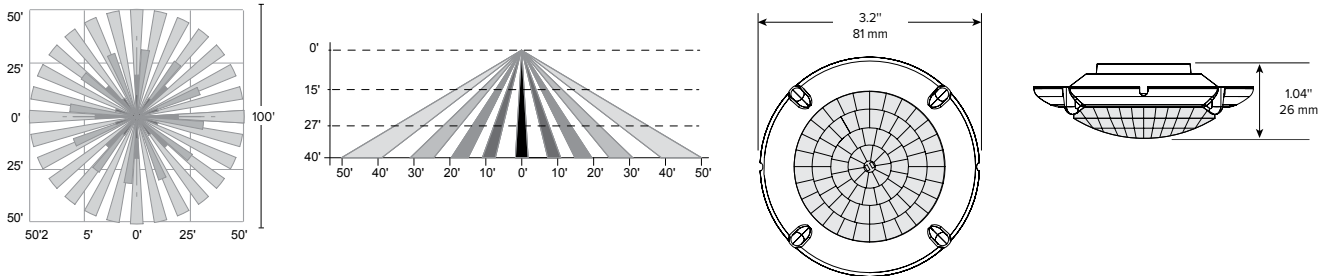

### RAR1 EPA

RAR-1	
EPA at 0°	EPA at 30°
.45ft. <sup>2</sup> .13m <sup>2</sup>	.56ft. <sup>2</sup> .17m <sup>2</sup>

### RAR2 EPA

RAR-2	
EPA at 0°	EPA at 30°
.55ft. <sup>2</sup> .17m <sup>2</sup>	1.48ft. <sup>2</sup> .45m <sup>2</sup>

### SHIPPING

Catalog Number	G.W(kg)/CTN	Carton Dimensions		
		Length Inch (cm)	Width Inch (cm)	Height Inch (cm)
RAR1	15 (6.8)	20.75 (52.7)	15.125 (38.4)	6.9375 (17.6)
RAR2	19 (8.6)	25 (63.5)	15.125 (38.4)	6.9375 (17.6)

# RATIO SERIES

AREA/SITE LIGHTER

## ADDITIONAL INFORMATION (CONT'D)

### RATIO HOUSE SIDE SHIELD

RARx HSS-90-B-xx

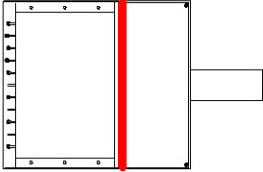

RARx HSS-270-BSS-xx

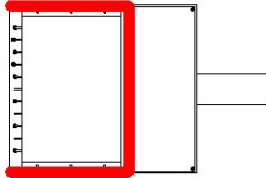

RARx HSS-360-xx

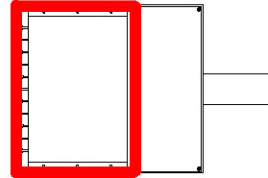

RARx HSS-90-F-xx

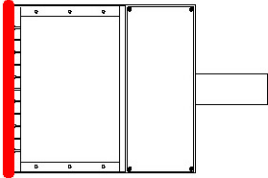

RARx HSS-270-FSS-xx

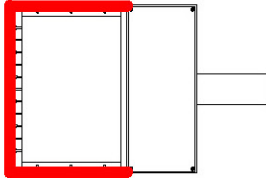

RARx HSS-90-S-xx

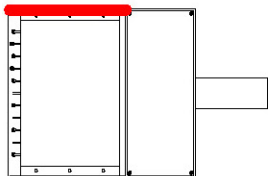

RARx HSS-270-FSB-xx

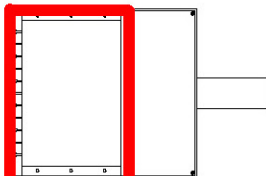

RARx HSS-90-S-xx

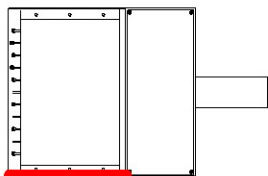

RARx HSS-270-FSB-xx

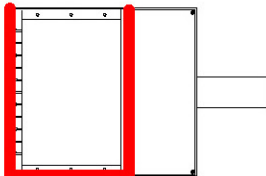

## USE OF TRADEMARKS AND TRADE NAMES

All product and company names, logos and product identifies are trademarks <sup>™</sup> or registered trademarks <sup>®</sup> of Hubbell Lighting, Inc. or their respective owners. Use of them does not necessarily imply any affiliation with or endorsement by such respective owners.