

Front

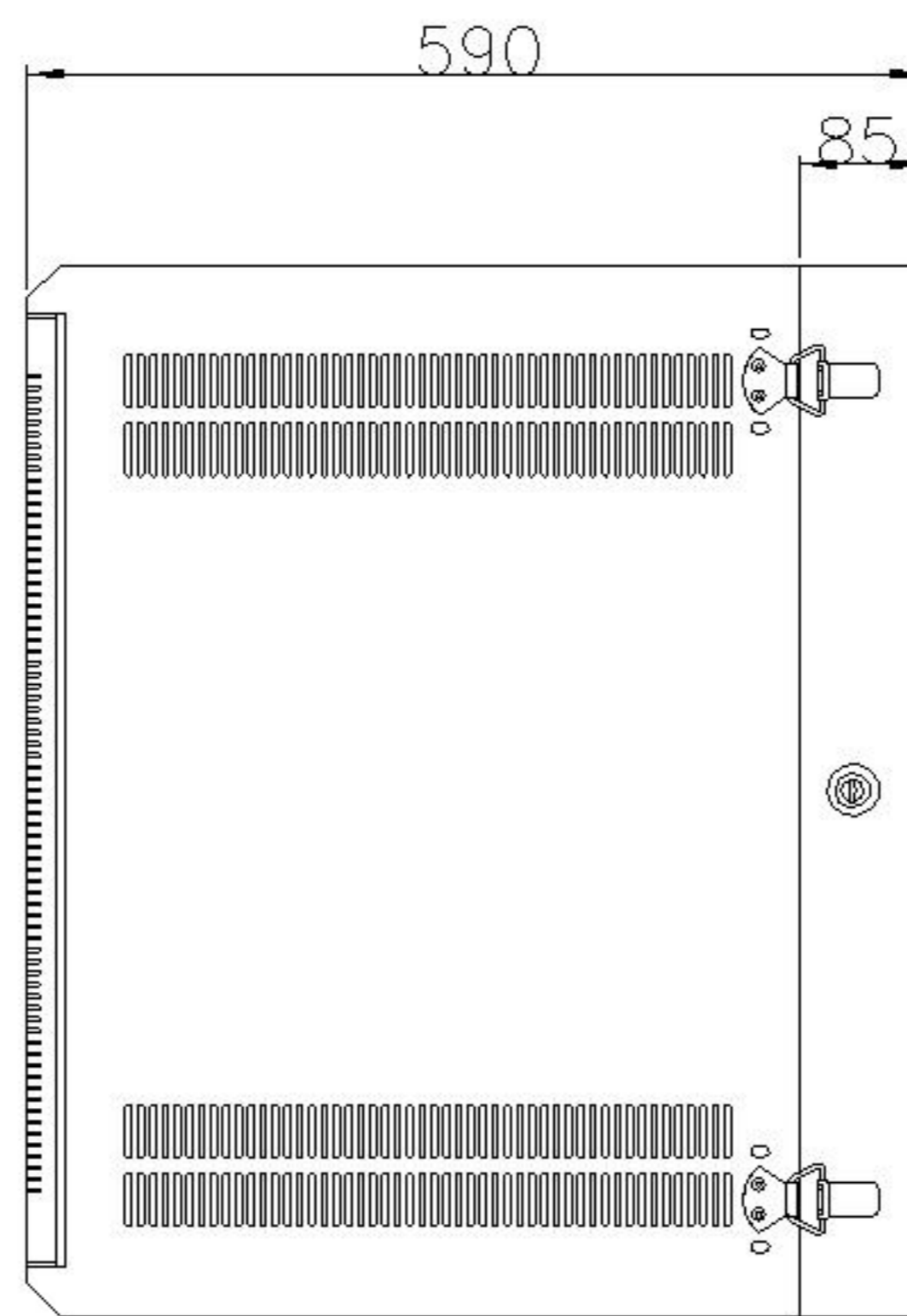

Side

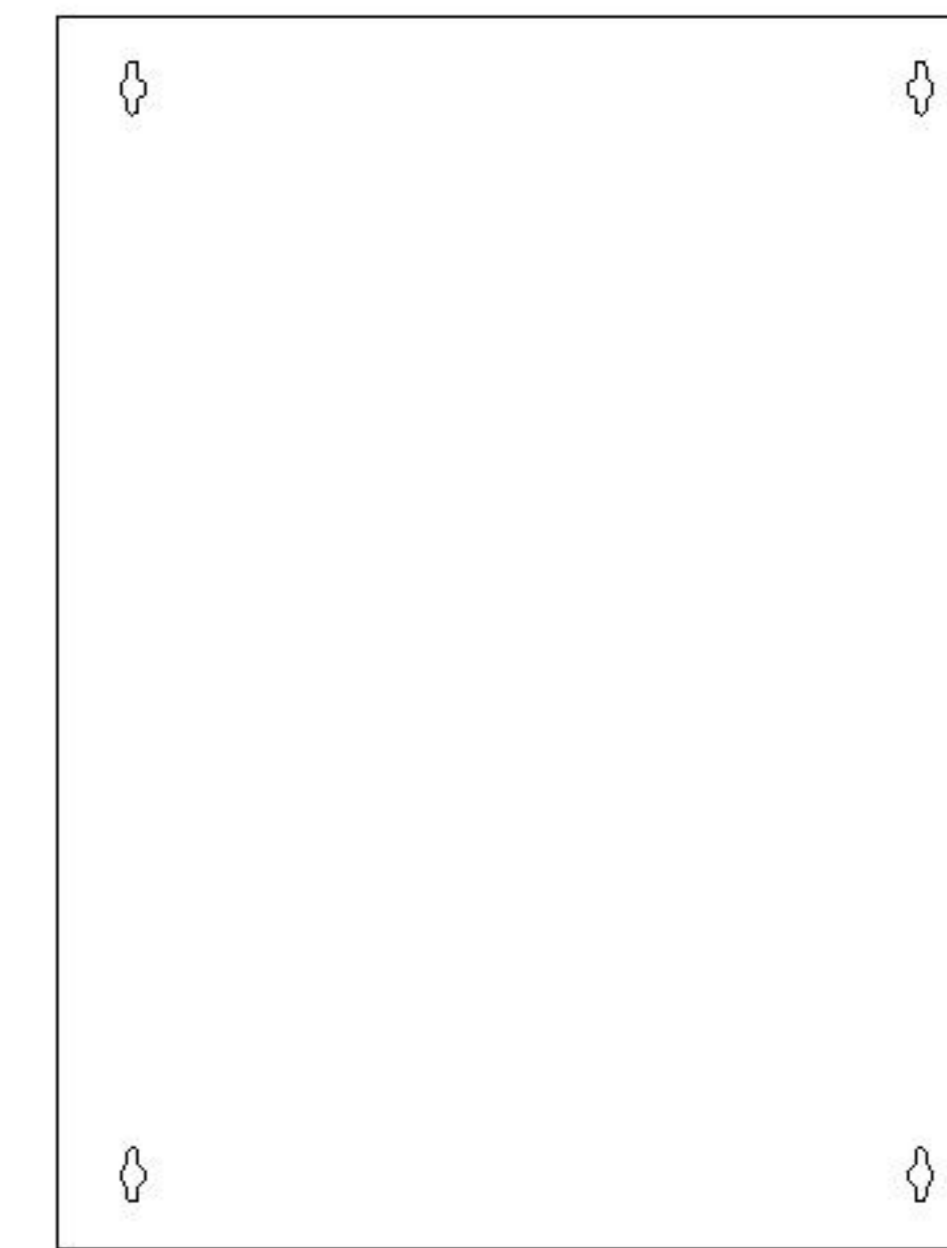

Back

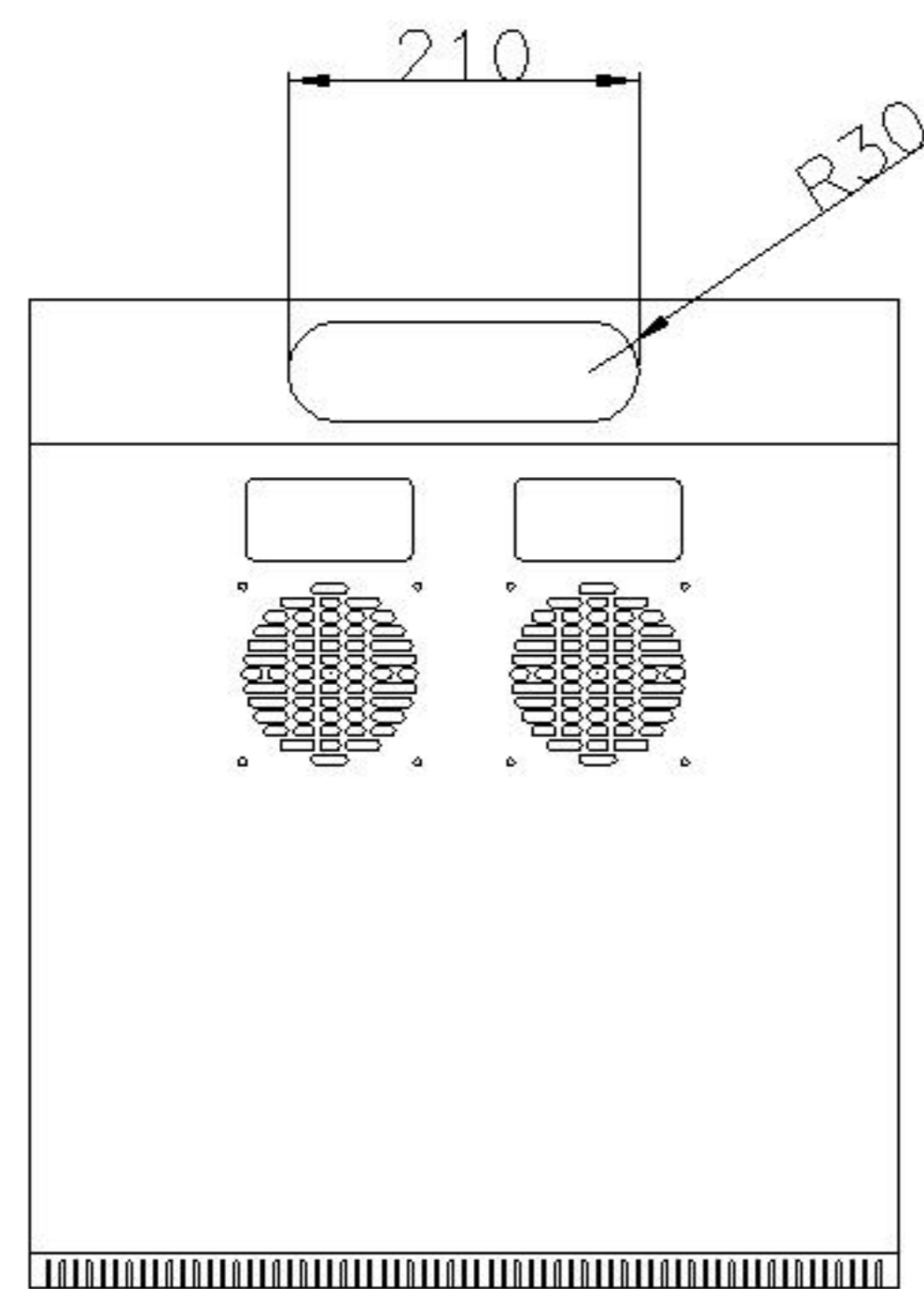

Top



QUEST MANUFACTURING CO.

11200 NW 13B St., Medley, FL 33178

TEL: 305-513-8583 FAX: 305-513-9675

WWW.QuestManufacturing.net

ITEM NO.

WM3019-14-02

Drawn By		Date		Material	C.R.S.	
Checked By		Date		Unit	mm	
Approved By		Date		Surface Finish	Power Coat	
				Scale	1:1	